

P/N: FAAISC-0805-082J

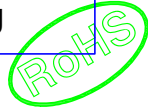

Outline Dimensions(Unit:mm)

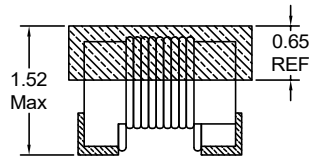

Side view

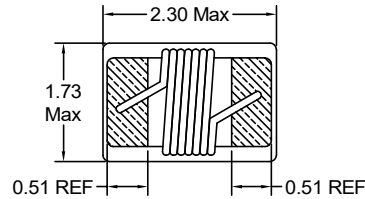

Bottom view

Recommended Soldering Temperature Graph.

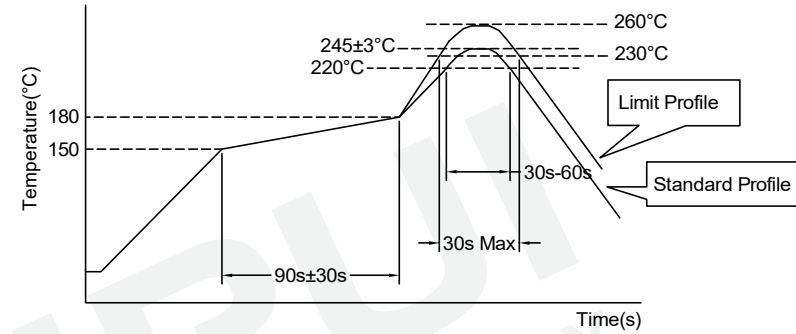

Electrical Schematic



Suggested Pad layout



H	1.78 REF
I	1.02 REF
J	0.76 REF

	Standard Profile	Standard Profile
Pre-heating	150~180°C,90s±30s	
Heating	above 220°C,30s-60s	above 240°C,30s Max
Peak temperature	245°C±3°C	260°C,10s
Cycle of reflow	2 times	2 times

Electrical Characteristics(@25°C)

Inductance 150MHz,0.1V	DC Resistance	Rated Current (A Max)	Q Min 500MHz	SRF GHZ Min
82.0nH±5%	420mΩ Max	400mA	65	1.30

General Specifications

- *Operating Temperature: -40°C~+125°C (Temperature rise included)
- *Storage Temperature: -40°C~+125°C
- *Storage Humidity:RH10%~70%.

Applications

- *Pagers,Cordless phone
- *High Freq.Communication Products
- *GPS(Global Position System)

				Tianchang Fuan Electronic Co Ltd www.fuantronics.net TEL: +86-550-7814888 FAX: +86-550-7831133	 Tolerances unless otherwise specified: (.X)±0.50 (.XX)±0.25 Unit of measurement: mm	Make: Qiumei.Liu Checked: Beson. zhan Approved: Anson. zhan	DRAWING TITLE SURFACE-MOUNT WIRE-WOUND CERAMIC CHIP INDUCTORS Material Number:	Customer Name: Document/Rev: 2211113/00 Specification Sheet: 1 of 4 Date of Recognition: Nov./03/2022
REV	DESCRIPTION	APPD	DATE					

P/N: FAAISC-0805-082J

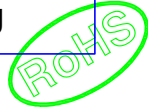

Packing Specifications(Unit:mm):

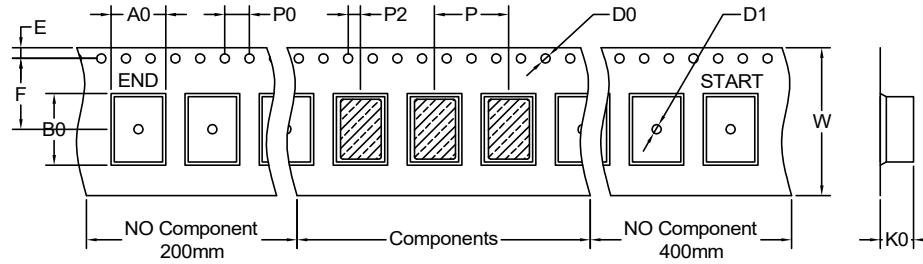

A0	1.30	F	3.50
B0	1.90	D0	1.50
P	2.00	D1	1.50
P0	4.00	K0	1.62
P2	2.00	W	8.00
E	1.75		



Quantity:2000pcs/Reel

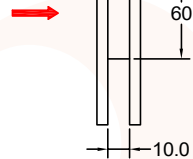

Quantity:2000pcs

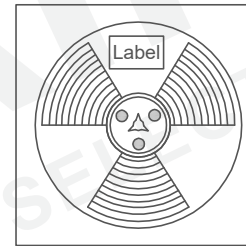

Inner box
Quantity: 20000 pcs/box

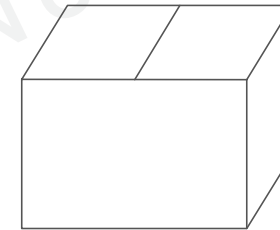

Outer cases: 120000pcs/box
Insufficient boxes filled with inner boxes or fillers

PAIRUI
SIMPLE SPEC FOR SELF PROTECTION ONLY

				Tianchang Fuan Electronic Co Ltd www.fuantronics.net TEL: +86-550-7814888 FAX: +86-550-7831133	 Tolerances unless otherwise specified: (.X)±0.50 (.XX)±0.25 Unit of measurement: mm	Make: Qiumei.Liu	DRAWING TITLE SURFACE-MOUNT WIRE-WOUND CERAMIC CHIP INDUCTORS	Customer Name:
						Checked: Beson. zhan		Document/Rev: 221113/00
REV	DESCRIPTION	APPD	DATE		Approved: Anson. zhan	Material Number:		Specification Sheet: 2 of 4



Reliability Testing:

Ltem	Specified value	Test methods
High temperature Storage test Reference documents: MIL-STD-202G Method 108A	1.No case deformation or change in appearance. 2.ΔL/L≤10%. 3.ΔQ/Q≤30%. 4.ΔDCR/DCR≤10%.	Temperature:85±2°C Time:96±2 hours. Tested not less than 1 hour, not more than 2 hours at room temperature. 
Low temperature Storage test. Referencedocuments: IEC 68-2-1A 6.1 6.2	1.No case deformation or change in appearance. 2.ΔL/L≤10%. 3.ΔQ/Q≤30%. 4.ΔDCR/DCR≤10%.	Temperature:25±2°C Time:96±2 hours. Tested not less than 1 hour, not more than 2 hours at room temperature. 
Humidity test Reference Documents: MIL-STD-202G Method 103B	1.No case deformation or change in appearance. 2.ΔL/L≤10%. 3.ΔQ/Q≤30%. 4.ΔDCR/DCR≤10%.	1.Dry oven at a temperature of 40°±5°C for 24 hours. 2.Measurements At the end of this period 3.Exposure:Temperature:40±2°C, Humidity: 93±3%RH Time:96±2 hours. 4.Tested while the specimens are still in the chamber. 5. Tested not less than 1 hour, nor more than 2 hours at room temperature. 
Heat endurance of Reflow soldering	1.No case deformation or change in appearance. 2.ΔL/L≤10%. 3.ΔQ/Q≤30%. 4.ΔDCR/DCR≤10%.	Preheat:150°C,60 second. Solder:Sn/Ag/Cu. Solder: Temperature:260±5°C. Flux:Rosin flux. Reflow peak time 10 second at 260°C 

Ltem	Specified value	Test methods
Thermal shock test Reference documents: MIL-STD-202G Method 107G	1.No case deformation or change in appearance. 2.ΔL/L≤10%. 3.ΔQ/Q≤30%. 4.ΔDCR/DCR≤10%. For T:weiges≤28g:15 Min 28g≤weights≤136g:30 Min	First-40°C for T time,next+125°C Ttime as 1 cycle. Go through 20 cycles. 
Solderability test Reference documents: MIL-STD-202G Method 208H IPC J-STD-002B	Terminals area must have 95% Min. Solder coverage.	Dip pads in flux then dip in solder pot at 245±5°C for 5 second. Soler:Sn(93.5)Ag(3.5). Flux:Rosin flux.
Vibration test Reference documents: MIL-STD-202G Method 201A	1.No case deformation or change in appearance. 2.ΔL/L≤10%. 3.ΔQ/Q≤30%. 4.ΔDCR/DCR≤10%.	Apply frequency 10~55Hz. 0.75mm amplitude in each of perpendicular direction for 2 hours.(total 6 hours). 
Drop test Reference documents: MIL-STD-202G Method 203G	1.No case deformation or change in appearance. 2.ΔL/L≤10%. 3.ΔQ/Q≤30%. 4.ΔDCR/DCR≤10%. For T:weiges≤28g:15 Min 28g≤weights≤136g:30 Min	Packaged & Drop down from 1m with 981m/s2(100G)attitude in 1 angle 1 ridges & 2 surfaces orientations.
Terminal strength push test Reference documents: JIS C 5321:1997	Pulling test: DEFINE:A:sectional area of terminal A≤8(Sq M) Force≥5N time:30sec 8(Sq M)<A≤20(Sq M) Force≥10N time:10sec 20(Sq M)<A force≥20N time:10sec Bending test: Soldering the products on PCB,after the pulling testand bending test, terminal should not pull off	Bend the testing PCB at middle point, the deflection shall be 2mm 

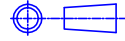
REV	DESCRIPTION	APPD	DATE	Tianchang Fuan Electronic Co Ltd www.fuantronics.net TEL: +86-550-7814888 FAX: +86-550-7831133	 Tolerances unless otherwise specified: (.X)±0.50 (.XX)±0.25 Unit of measurement: mm	Make: Qiumei.Liu Checked: Beson. zhan Approved: Anson. zhan	DRAWING TITLE SURFACE-MOUNT WIRE-WOUND CERAMIC CHIP INDUCTORS Material Number:	Customer Name:
								Document/Rev: 221113/00
								Specification Sheet: 3 of 4
								Date of Recognition: Nov./03/2022

P/N: FAAISC-0805-082J

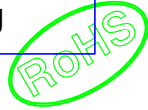

Ltem	Specified value	Test methods
Resistance to solvent test Reference documents: IEC 68-2-45:1993	No case deformation or change in appearance, or obliteration of marking	To dip parts into IPA solvent for 5±0.5Min, then drying them at room temp for 5 Min, at last, to brushing making 10 times.
Electronic characteristic test of major products	Refer to catalogue of specific products	Refer to catalogue of specific products
Overload test Reference documents:	1. During the test no smoke, no peculiar, smell, no fire	Apply twice as rated current for 5 minutes.

Recommended solderability temperature profile:



Use rosin-based flux
Don't use high acidic flux with halide content exceeding 0.2(wt)% (chlorine conversion value).
Use lead-free solder, use Sn-3.0Ag-0.5Cu solder
Standard thickness of solder paste: 0.12-0.15mm

				Tianchang Fuan Electronic Co Ltd www.fuantronics.net TEL: +86-550-7814888 FAX: +86-550-7831133	 Tolerances unless otherwise specified: (.X)±0.50 (.XX)±0.25 Unit of measurement: mm	Make: Qiumei.Liu Checked: Beson. zhan Approved: Anson. zhan	DRAWING TITLE SURFACE-MOUNT WIRE-WOUND CERAMIC CHIP INDUCTORS Material Number:	Customer Name: Document/Rev: 2211113/00 Specification Sheet: 4 of 4 Date of Recognition: Nov./03/2022
REV	DESCRIPTION	APPD	DATE					