

P/N: FACSB1235-2R2M

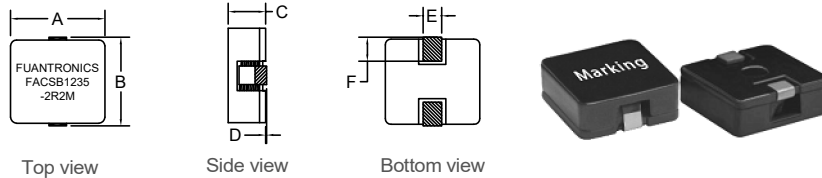

Outline Dimensions(Unit:mm)



A	B	C	D	E	F
±0.50	±1.00	±0.30		±0.50	±1.00
12.8	13.0	3.30	0-0.2	2.50	3.00

Electronical Schematic

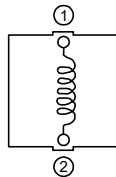

Suggested Pad layout



H	5.50 REF
I	4.50 REF
J	6.00 REF

Saturation current VS temperature rise current curve:

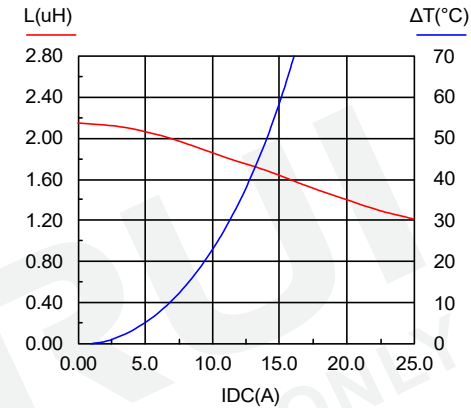

Recommended Soldering Temperature Graph.

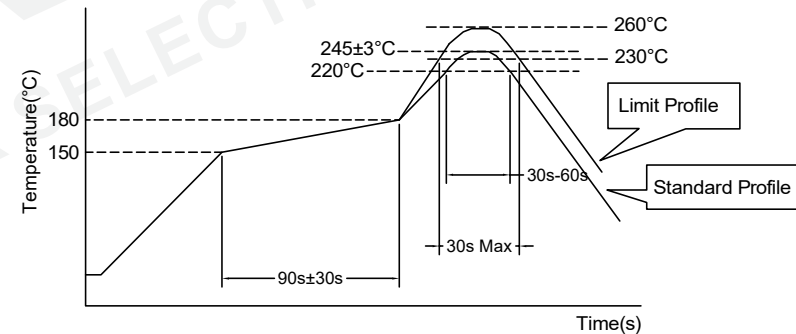

- ***Magnetic shielded structure: excellent resistance to electro magnetic interferenc(EMI).
- ***Flat wire winding, achieve a low D.C. Resistance.
- ***Low loss, high efficiency, wide application frequency and application scope.
- ***Lightweight design, save space, suitable for high density SMT.

Electrical Characteristics(@25°C)

Inductance 100KHz,0.1V	DC Resistor	Saturated current 18A	Temperature rise current 14A
2.20uH±20%	6.30mΩ Max	L(18A)=70%*L0A Typ	T≤50°C Typ

- ***Saturation current: the actual value of DC current when the inductance decrease 30% of its initial value.
- ***Temperature rise current: the actual value of DC current when the temperature rise is ΔT50°C(Ta=25°C).
- ***Operating Temperature: -40°C~+125°C. (Temperature rise included)
- ***Storage Temperature: -40°C~+125°C.
- ***Storage Humidity:RH10%~70%.

	Standard Profile	Standard Profile
Pre-heating	150~180°C,90s±30s	
Heating	above 220°C,30s-60s	above 240°C,30s Max
Peak temperature	245°C±3°C	260°C,10s
Cycle of reflow	2 times	

REV	DESCRIPTION	APPD	DATE	Tianchang Fuan Electronic Co Ltd www.fuantronics.net TEL: +86-550-7814888 FAX: +86-550-7831133	 Tolerances unless otherwise specified: (X)±0.50 (XX)±0.25 Unit of measurement: mm	Make: Qiumei.Liu	DRAWING TITLE HIGH CURRENT POWER INDUCTORS	Customer Name:
						Checked: Beson. zhan		Material Number: A341235XS050
						Approved: Anson. zhan		Specification Sheet: 1 of 1
								Date of Recognition: Jan./02/2020