

P/N: FACPCF2014A-3R3MC

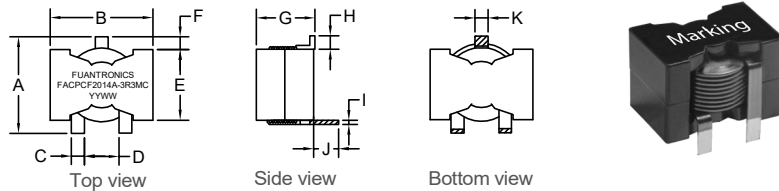

Outline Dimensions(Unit:mm)



A	B	C	D	E	F	G	H	I	J	K
Max	Max	±0.30	±0.60	Max	±0.30	Max	±0.30	±0.20	±1.00	±0.20
21.0	21.8	2.50	7.00	14.5	2.50	14.5	2.00	0.70	5.00	2.50

Electronical Schematic



Suggested Pad layout

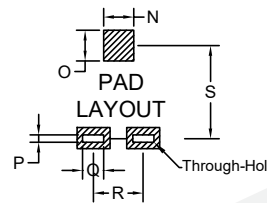

N	5.00 REF
O	5.00 REF
P	1.20 REF
Q	3.50 REF
R	9.50 REF
S	15.7 REF

- ***Assemblage design, sturdy structure.
- ***High inductance, high current, low magnetic loss, low ESR, small parasitic capacitance.
- ***Flat wire winding, achieve a low D.C. Resistance.
- ***Temperature rise current and saturation current is less influenced by environment.

Electrical Characteristics(@25°C)

Inductance 100KHz,0.1V	DC Resistor	Saturated current 48.0A	Temperature rise current 24A
3.30uH±20%	3.80mΩ Max	L(48.0A)=80%*L0A Typ	T≤40°C Typ

- ***Saturation current: the actual value of DC current when the inductance decrease 20% of its initial value.
- ***Temperature rise current: the actual value of DC current when the temperature rise is ΔT40°C(Ta=25°C).
- ***Operating Temperature: -40°C~+125°C (Temperature rise included)
- ***Storage Temperature: -40°C~+125°C
- ***Storage Humidity:RH10%~70%.

Saturation current VS temperature rise current curve:

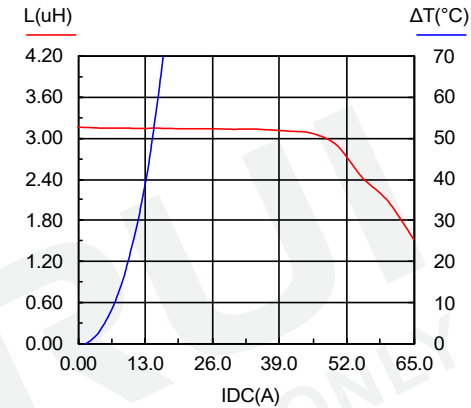

Recommended Soldering Temperature Graph.

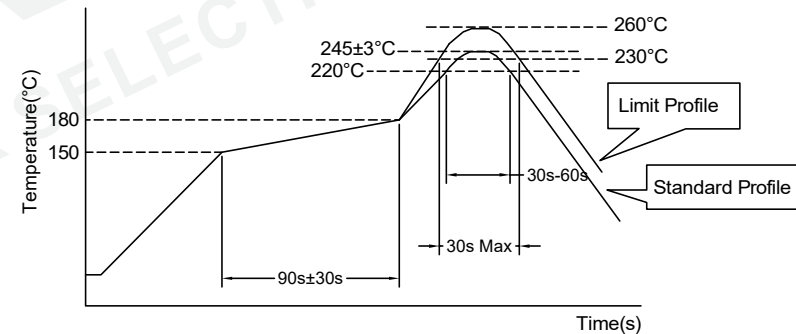

	Standard Profile	Standard Profile
Pre-heating	150~180°C,90s±30s	
Heating	above 220°C,30s-60s	above 240°C,30s Max
Peak temperature	245°C±3°C	260°C,10s
Cycle of reflow	2 times	