

P/N: FACCF2118H-103Y2R8-P1

Outline Dimensions(Unit:mm)

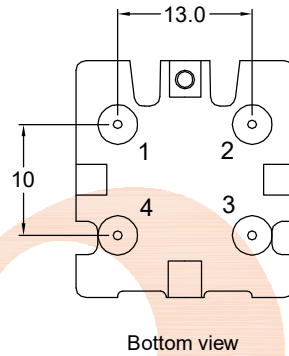

Electronical Schematic

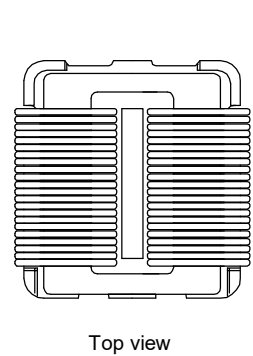
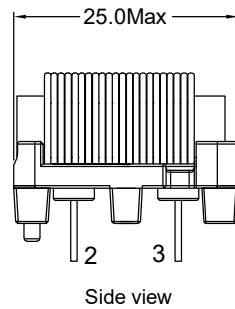
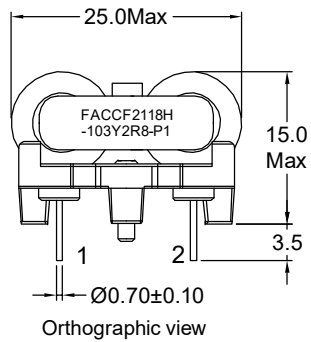
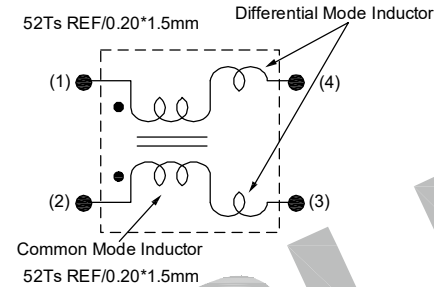

Simulation test curve:

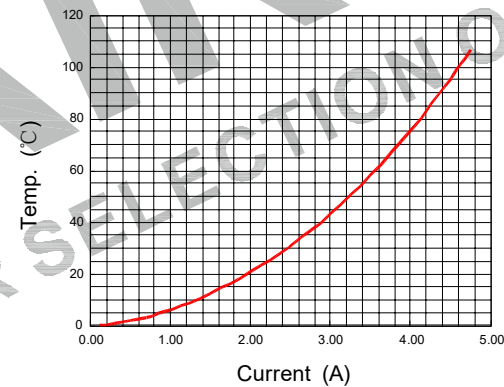

Electrical Characteristics(at 25°C)

Inductance : 10.0mH Min,at 1KHz,0.25V.
 Lstray: Lkg=140uH typ,at 1KHz,0.25V.
 Inductance balance : L1-L2= 300uH Max,at 1KHz,0.25V.
 D.C.Resistance: 100 mohms Max.
 Rated current: 2.8Amps.
 Turns Ratio : 1:1±2%,at 20KHz,1V.
 Hipot : Pri-Sec : 1500VAC/5mA/2Second.

List of UL Certificate:

Part Name	Mat'l Description	Supplier	UL Number
Bobbin	SQ2118/T375HF	Chang Chun Plastics Co Ltd	E59481
Copper wire	SFT-UEW-H	Ningbo Jintian New Material Co Ltd	E227047
Core	SQ2118-H10K	Su Zhou Tian Ming Magnetic	N/A
Epoxy	YZ-HC-1401C	YouZhi Electronic(DongGuan)Co.,Ltd	N/A
or Varnish	T4260LZ	Suzhou Taihu Electric Advanced Material Co., Ltd	E228349

***Weight:Approx 21.0g.

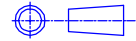
				Tianchang Fuan Electronic Co Ltd www.fuantronics.net TEL: +86-550-7814888 FAX: +86-550-7831133		 Tolerances unless otherwise specified: (X)±0.50 (XX)±0.25 Unit of measurement: mm		Make: Yuing.yu Checked: Beson. zhan Approved: Anson. zhan		DRAWING TITLE CCF2118H Current-compensated frame core double chokes Material Number:		Customer P/N: Document/Rev: 2207465/00 Specification Sheet: 1 of 1 Date of Recognition: July./23/2022	
REV	DESCRIPTION	APPD	DATE										