

MOUNTING CLIP

DRAWING NO:UU-15.7-1

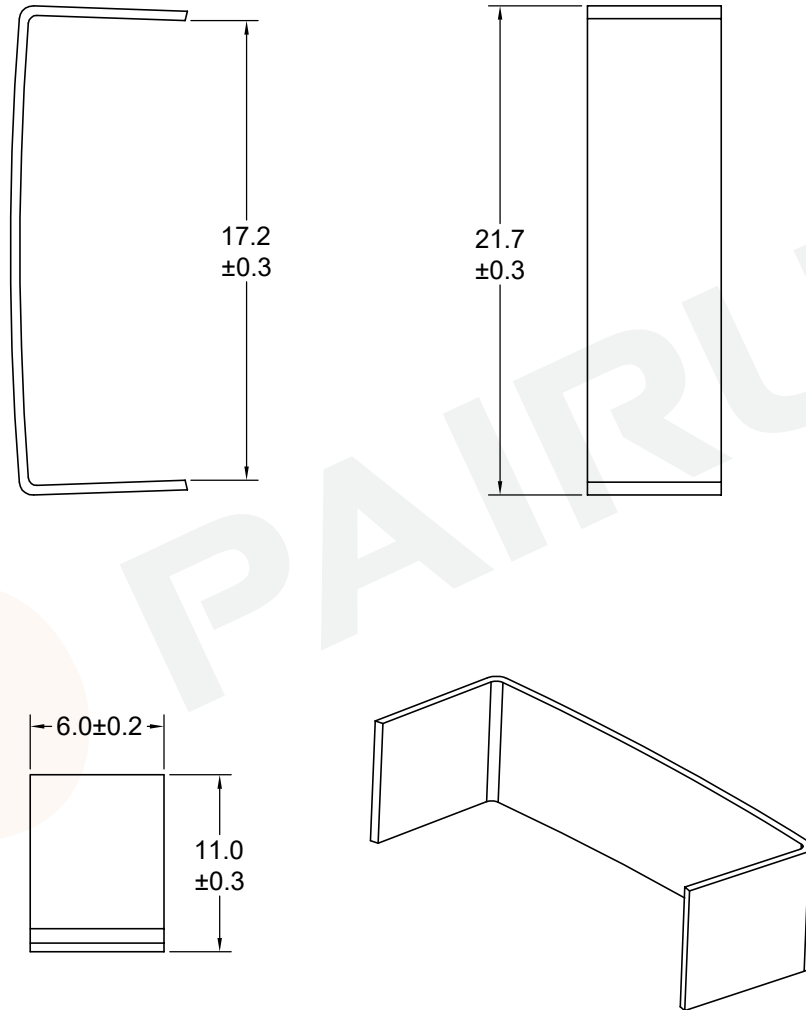

Tolerances unless otherwise specified:
 0<L≤4±0.10 4<L≤16±0.20
 16<L≤45±0.30 45≤L±0.40
 Wall thickness:0.50±0.05 Angle: ±1°

Dimensions:
(mm)

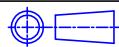

REMARK

Mould No.:	Clip Material: SUS301 0.5T
Code No.: :FAY01045	UL Recognition:



Fuan Electronics
 TEL :0086-514-87693589
 EML :sales@fuantronics.net
 WEB:www.fuantronics.net

Make: P.Xiao	Material Number: 221UU1570000
Checked: Beson. zhan	Document/Rev: 00
Approved: Anson. zhan	Date of Recognition: Dec./09/2019