

P/N: FASDRH1207-100M5R4

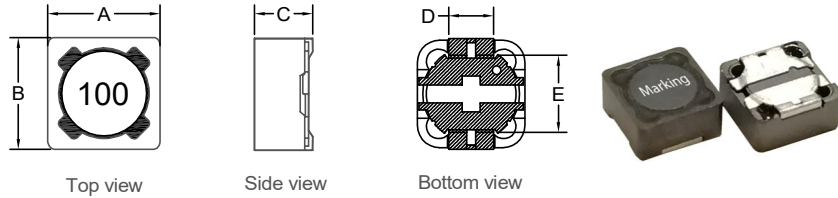

Outline Dimensions(Unit:mm)



| A | B | C | D | E |
|------|------|------|------|------|
| Max | Max | Max | REF | REF |
| 12.3 | 12.3 | 8.00 | 5.00 | 7.60 |

Recommended Soldering Temperature Graph.

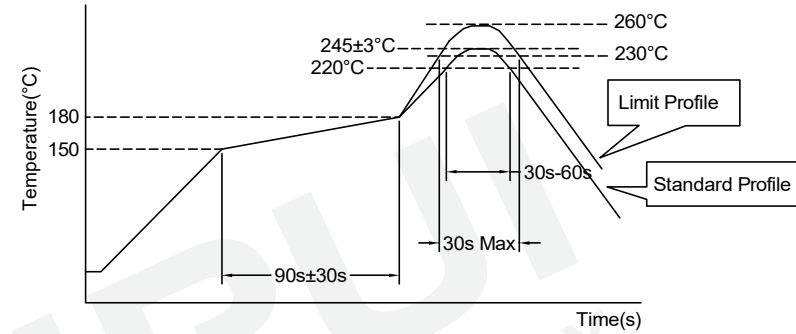

Electronical Schematic



Suggested Pad layout

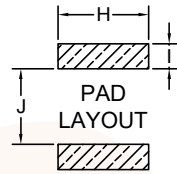

| | |
|---|----------|
| H | 5.40 REF |
| I | 3.00 REF |
| J | 7.00 REF |

| | Standard Profile | Standard Profile |
|------------------|---------------------|---------------------|
| Pre-heating | 150~180°C,90s±30s | |
| Heating | above 220°C,30s-60s | above 240°C,30s Max |
| Peak temperature | 245°C±3°C | 260°C,10s |
| Cycle of reflow | 2 times | 2 times |

Electrical Characteristics(@25°C)

| Inductance 1KHz,0.25V | DC Resistor | Isat (A Max) |
|--------------------------|-------------|------------------|
| 10.0uH±20% | 0.022Ω Max | L(5.40A)≥75%*L0A |

***Operating Temperature: -40°C~+125°C
(Temperature rise included)

***Storage Temperature: -40°C~+125°C

***Storage Humidity:RH10%~70%

***Weight:Approx 3.96g.

| | | | | | | | | |
|-----|-------------|------|------|---|---|---|--|---|
| | | | | Tianchang Fuan Electronic Co Ltd www.fuantronics.net TEL: +86-550-7814888 FAX: +86-550-7831133 | Tolerances unless otherwise specified: (.X)±0.50 (.XX)±0.25 Unit of measurement: mm | Make: Qiumei.Liu Checked: Beson. zhan Approved: Anson. zhan | DRAWING TITLE SMD SHIELDED POWER INDUCTORS Material Number: A341207HS040 | Customer Name: Document/Rev: 00 Specification Sheet: 1 of 4 Date of Recognition: July./14/2020 |
| REV | DESCRIPTION | APPD | DATE | | | | | |

P/N: FASDRH1207-100M5R4

RoHS

Packing Specifications(Unit:mm):

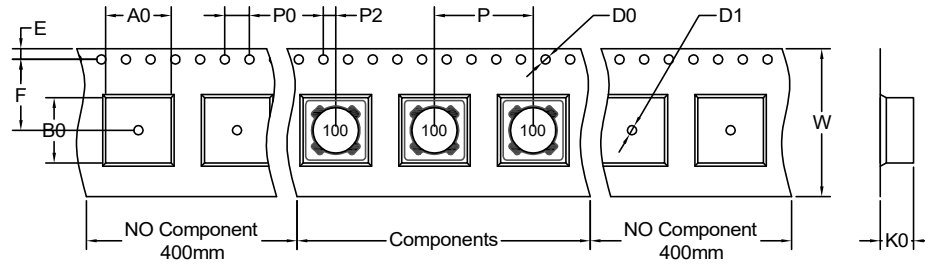

| | | | |
|----|------|----|------|
| A0 | 12.6 | F | 11.5 |
| B0 | 12.8 | D0 | 1.50 |
| P | 16.0 | D1 | 1.50 |
| P0 | 4.00 | K0 | 8.25 |
| P2 | 2.00 | W | 24.0 |
| E | 1.75 | | |

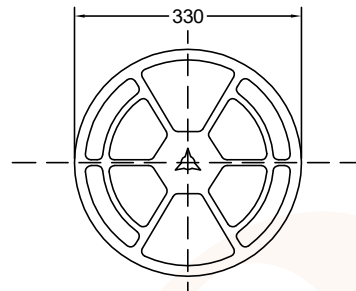

Quantity:500pcs/Reel

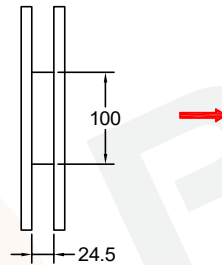

Quantity: 500pcs



PE bag

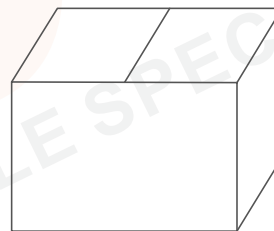

Outer cases: 3000pcs/box
Insufficient boxes filled with inner boxes or fillers



Inner box
Quantity: 1500 pcs/box

| | | | |
|-----|-------------|------|------|
| REV | DESCRIPTION | APPD | DATE |
|-----|-------------|------|------|

Tianchang Fuan Electronic Co Ltd
www.fuantronics.net
TEL: +86-550-7814888
FAX: +86-550-7831133

Tolerances unless otherwise specified:
(.X)±0.50 (.XX)±0.25
Unit of measurement: mm

Make: Qiumei.Liu
Checked: Beson. zhan
Approved: Anson. zhan

DRAWING TITLE
SMD SHIELDED
POWER INDUCTORS
Material Number: A341207HS040

Customer Name:
Document/Rev: 00
Specification Sheet: 2 of 4
Date of Recognition: July./14/2020

P/N: FASDRH1207-100M5R4



Reliability Testing:

| Ltem | Specified value | Test methods |
|---|---|---|
| High temperature Storage test Reference documents: MIL-STD-202G Method 108A | 1.No case deformation or change in appearance. 2. $\Delta L/L \leq 10\%$. 3. $\Delta Q/Q \leq 30\%$. 4. $\Delta DCR/DCR \leq 10\%$. | Temperature: $85 \pm 2^\circ\text{C}$ Time: 96 ± 2 hours. Tested not less than 1 hour, not more than 2 hours at room temperature.  |
| Low temperature Storage test. Referencedocuments: IEC 68-2-1A 6.1 6.2 | 1.No case deformation or change in appearance. 2. $\Delta L/L \leq 10\%$. 3. $\Delta Q/Q \leq 30\%$. 4. $\Delta DCR/DCR \leq 10\%$. | Temperature: $25 \pm 2^\circ\text{C}$ Time: 96 ± 2 hours. Tested not less than 1 hour, not more than 2 hours at room temperature.  |
| Humidity test Reference Documents: MIL-STD-202G Method 103B | 1.No case deformation or change in appearance. 2. $\Delta L/L \leq 10\%$. 3. $\Delta Q/Q \leq 30\%$. 4. $\Delta DCR/DCR \leq 10\%$. | 1.Dry oven at a temperature of $40^\circ \pm 5^\circ\text{C}$ for 24 hours. 2.Measurements At the end of this period 3.Exposure:Temperature: $40 \pm 2^\circ\text{C}$,Humidity: $93 \pm 3\% \text{RH}$ Time: 96 ± 2 hours. 4.Tested while the specimens are still in the chamber. 5.Tested not less than 1 hour, nor more than 2 hours at room temperature.  |
| Heat endurance of Reflow soldering | 1.No case deformation or change in appearance. 2. $\Delta L/L \leq 10\%$. 3. $\Delta Q/Q \leq 30\%$. 4. $\Delta DCR/DCR \leq 10\%$. | Preheat: 150°C ,60 second. Solder:Sn/Ag/Cu. Solder:Temperature: $260 \pm 5^\circ\text{C}$. Flux:Rosin flux. Reflow peak time 10 second at 260°C  |

| Ltem | Specified value | Test methods |
|--|---|--|
| Thermal shock test Reference documents: MIL-STD-202G Method 107G | 1.No case deformation or change in appearance. 2. $\Delta L/L \leq 10\%$. 3. $\Delta Q/Q \leq 30\%$. 4. $\Delta DCR/DCR \leq 10\%$. For T:weiges $\leq 28\text{g}$:15 Min 28g \geq weights $\leq 136\text{g}$:30 Min | First- 40°C for T time,next+ 125°C Ttime as 1 cycle. Go through 20 cycles.  |
| Solderability test Reference documents: MIL-STD-202G Method 208H IPC J-STD-002B | Terminals area must have 95% Min. Solder coverage. | Dip pads in flux then dip in solder pot at $245 \pm 5^\circ\text{C}$ for 5 second. Soler:Sn(93.5)Ag(3.5). Flux:Rosin flux. |
| Vibration test Reference documents: MIL-STD-202G Method 201A | 1.No case deformation or change in appearance. 2. $\Delta L/L \leq 10\%$. 3. $\Delta Q/Q \leq 30\%$. 4. $\Delta DCR/DCR \leq 10\%$. | Apply frequency 10~55Hz. 0.75mm amplitude in each of perpendicular direction for 2 hours.(total 6 hours).  |
| Drop test Reference documents: MIL-STD-202G Method 203G | 1.No case deformation or change in appearance. 2. $\Delta L/L \leq 10\%$. 3. $\Delta Q/Q \leq 30\%$. 4. $\Delta DCR/DCR \leq 10\%$. For T:weiges $\leq 28\text{g}$:15 Min 28g \geq weights $\leq 136\text{g}$:30 Min | Packaged & Drop down from 1m with 981m/s^2 (100G)attitude in 1 angle 1 ridges & 2 surfaces orientations. |
| Terminal strength push test Reference documents: JIS C 5321:1997 | Pulling test: DEFINE:A:sectional area of terminal $A \leq 8(\text{Sq M})$ $8(\text{Sq M}) < A \leq 20(\text{Sq M})$ Force $\geq 5\text{N}$ time:30sec $8(\text{Sq M}) < A \leq 20(\text{Sq M})$ Force $\geq 10\text{N}$ time:10sec $20(\text{Sq M}) < A$ force $\geq 20\text{N}$ time:10sec Bending test: Soldering the products on PCB,after the pulling testand bending test, terminal should not pull off | Bend the testing PCB at middle point, the deflection shall be 2mm  |

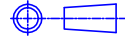
| | | | | | | | | |
|-----|-------------|------|------|---|--|---|--|---|
| REV | DESCRIPTION | APPD | DATE | Tianchang Fuan Electronic Co Ltd www.fuantronics.net TEL: +86-550-7814888 FAX: +86-550-7831133 |  Tolerances unless otherwise specified: (.X) ± 0.50 (.XX) ± 0.25 Unit of measurement: mm | Make: Qiumei.Liu Checked: Beson. zhan Approved: Anson. zhan | DRAWING TITLE SMD SHIELDED POWER INDUCTORS Material Number: A341207HS040 | Customer Name: |
| | | | | | | | | Document/Rev: 00 Specification Sheet: 3 of 4 Date of Recognition: July./14/2020 |

P/N: FASDRH1207-100M5R4



| Ltem | Specified value | Test methods |
|--|---|--|
| Resistance to solvent test Reference documents: IEC 68-2-45:1993 | No case deformation or change in appearance, or obliteration of marking | To dip parts into IPA solvent for 5±0.5Min, then drying them at room temp for 5 Min, at last, to brushing making 10 times. |
| Electronic characteristic test of major products | Refer to catalogue of specific products | Refer to catalogue of specific products |
| Overload test Reference documents: | 1. During the test no smoke, no peculiar, smell, no fire | Apply twice as rated current for 5 minutes. |

Recommended solderability temperature profile:

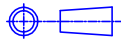

Use rosin-based flux
Don't use high acidic flux with halide content exceeding 0.2(wt)% (chlorine conversion value).
Use lead-free solder, use Sn-3.0Ag-0.5Cu solder
Standard thickness of solder paste: 0.12-0.15mm

| | | | | | | | | |
|-----|-------------|------|------|---|--|---|--|---|
| | | | | Tianchang Fuan Electronic Co Ltd www.fuantronics.net TEL: +86-550-7814888 FAX: +86-550-7831133 |  Tolerances unless otherwise specified: (.X)±0.50 (.XX)±0.25 Unit of measurement: mm | Make: Qiumei.Liu Checked: Beson. zhan Approved: Anson. zhan | DRAWING TITLE SMD SHIELDED POWER INDUCTORS Material Number: A341207HS040 | Customer Name: Document/Rev: 00 Specification Sheet: 4 of 4 Date of Recognition: July./14/2020 |
| REV | DESCRIPTION | APPD | DATE | | | | | |