

P/N: FALCH4W1014-562K

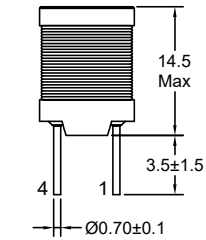

Outline Dimensions(Unit:mm)



Orthographic view



Top view

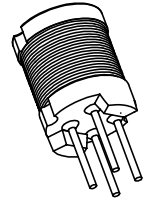

Stereogram

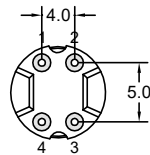

Bottom view

Electrical Schematic

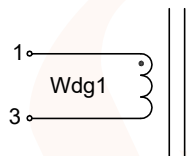

Electrical Characteristics(@25°C)

Inductance 1KHz,0.1V 1-3	DC Resistor 1-3	Rated Current
5600uH±10%	8.20Ω Max	0.21A

\*\*\*Operating Temperature: -40°C~+125°C.  
(Temperature rise included)  
\*\*\*Storage Temperature : -40°C~+125°C.  
\*\*\*Storage Humidity:RH10%~70%.

Material list

Part Name	SPEC	Material Type	Supplier	UL Number
Core	DR4W10*14 (S)RCH (B=5.0)	NiZn	FengYin Electronics Corporation or Equivalent supplier	N/A
Copper Wire	2UEW-F	155°C	Elektrisola Hangzhou Co Ltd	E258243

Recommended Soldering Temperature Graph.

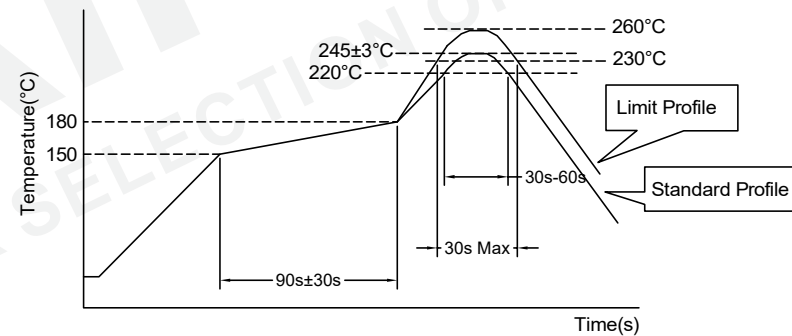

	Standard Profile	Standard Profile
Pre-heating	150~180°C,90s±30s	
Heating	above 220°C,30s-60s	above 240°C,30s Max
Peak temperature	245°C±3°C	260°C,10s
Cycle of reflow	2 times	

REV	DESCRIPTION	APPD	DATE	Tianchang Fuan Electronic Co Ltd www.fuantronics.net TEL: +86-550-7814888 FAX: +86-550-7831133	 Tolerances unless otherwise specified: (.X)±0.50 (.XX)±0.25 Unit of measurement: mm	Make: Qiumei.Liu Checked: Beson. zhan Approved: Anson. zhan	<b>DRAWING TITLE</b> DR4W10*14 RADIAL FILTER CHOKE Material Number: A331014XS350	Customer Name: Document/Rev: 00 Specification Sheet: 1 of 1 Date of Recognition: Jan./02/2020
-----	-------------	------	------	---	---	---	---	--