

P/N: FALCH0807-822K

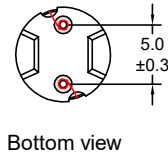

Outline Dimensions(Unit:mm)

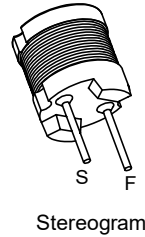
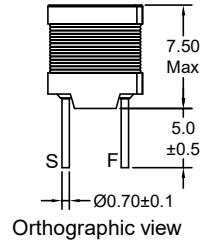

Material list

Part Name	SPEC	Material Type	Supplier	UL Number
Core	DR2W7.8*7(S) RCH(B=3.5)	NiZn	FengYin Electronics Corporation or Equivalent supplier	N/A
Copper Wire	2UEW-F	155°C	Elektrisola Hangzhou Co Ltd	E258243

Electrical Schematic

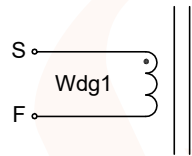

Recommended Soldering Temperature Graph.

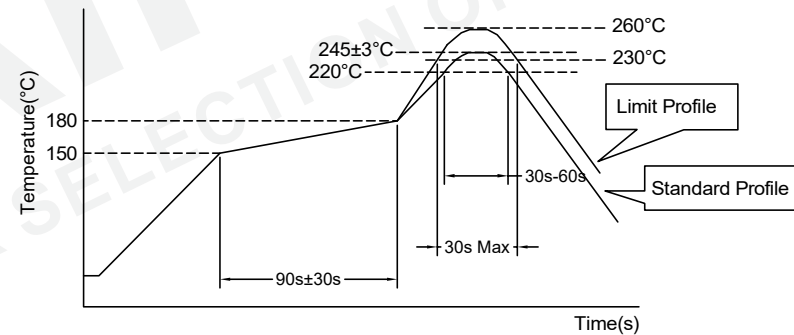

Electrical Characteristics(@25°C)

Inductance 1KHz,0.1V S-F	DC Resistor S-F	Rated Current
8200uH±10%	28.7Ω Max	0.093A

***Operating Temperature: -40°C~+125°C
(Temperature rise included)
***Storage Temperature: -40°C~+125°C
***Storage Humidity:RH10%~70%.

	Standard Profile	Standard Profile
Pre-heating	150~180°C,90s±30s	
Heating	above 220°C,30s-60s	above 240°C,30s Max
Peak temperature	245°C±3°C	260°C,10s
Cycle of reflow	2 times	

		Tianchang Fuan Electronic Co Ltd				Make: Qiumei.Liu		DRAWING TITLE		Customer Name:	
		www.fuantronics.net		Tolerances unless otherwise specified:		Checked: Beson. zhan		DR2W7.8*7 POWER INDUCTORS		Document/Rev: 00	
		TEL: +86-550-7814888		(.X)±0.50 (.XX)±0.25		Approved: Anson. zhan		Material Number: A330807XS350		Specification Sheet: 1 of 1	
		FAX: +86-550-7831133		Unit of measurement: mm						Date of Recognition: Mar./16/2020	
REV	DESCRIPTION	APPD	DATE								