

COIL FORMER

General data 24-pins ETD59/31/22 coil former

PARAMETER	SPECIFICATION
Coil former material	polyamid (PA66), glass reinforced, flame retardant in accordance with "UL 94HB"; UL file number E41938
Pin material	copper-tin alloy (CuSn), tin (Sn) plated
Maximum operating temperature	130 °C, "IEC 60085", class B
Resistance to soldering heat	"IEC 60068-2-20", Part 2, Test Tb, method 1B, 350 °C, 3.5 s
Soldeerability	"IEC 60068-2-20", Part 2, Test Ta, method 1

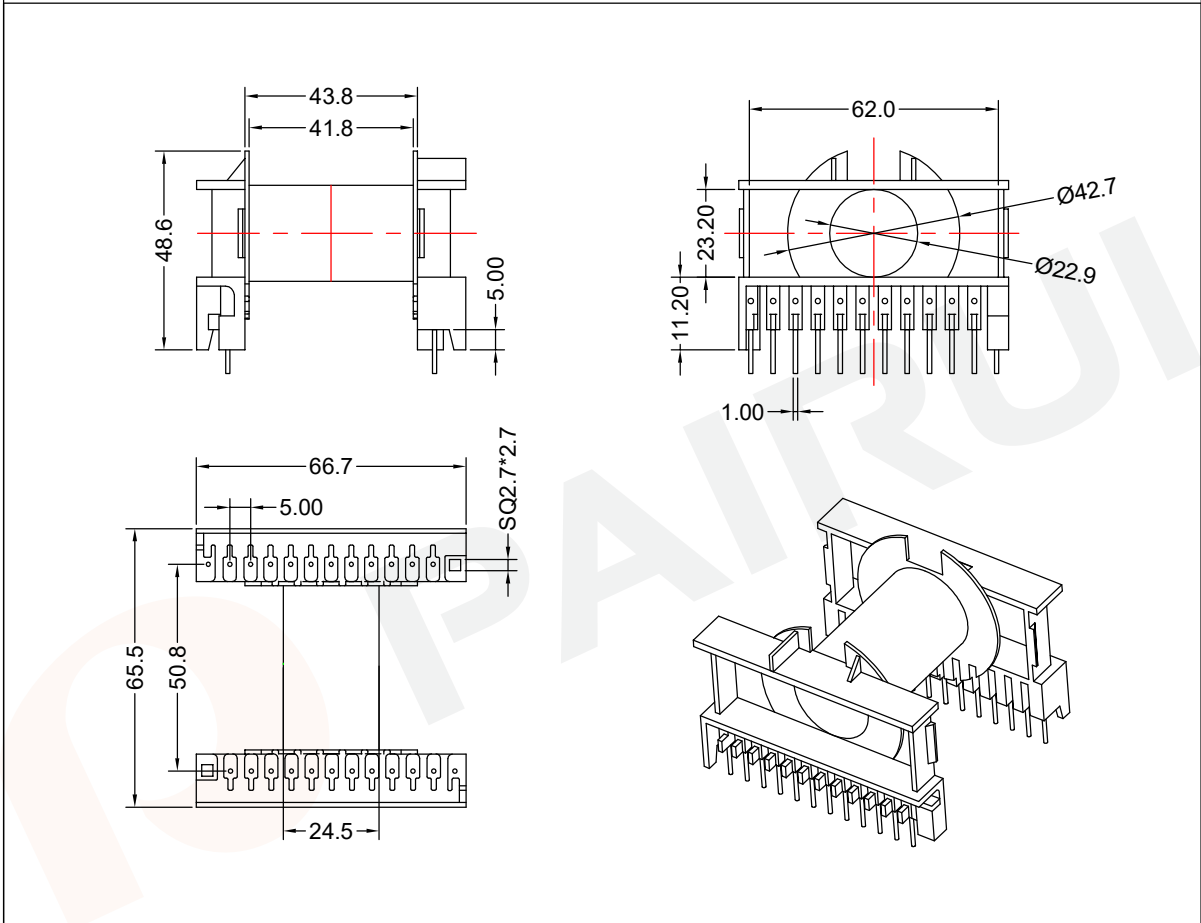

Winding data and area product for 24-pins ETD59/31/22 coil former

NUMBER OF SECTIONS	WINDING AREA (mm ²)	MINIMUM WINDING WIDTH (mm)	AVERAGE LENGTH OF TURN (mm)	AREA PRODUCT Ae x Aw (mm ⁴)	TYPE NUMBER
1	385	41.80	107	141680	ETD-5902-1S-24P

Tolerances unless otherwise specified:
 0<L≤4±0.10 4<L≤16±0.20
 16<L≤45±0.30 45≤L±0.40
 Pin Dim:±0.05 Thickness:±0.20 Pin Pitch:±0.20

Dimensions:
(mm)



REMARK

Mould No.: ETD5901

Bobbin material: PA66

Code No.: FAY01091

Available for Fuan core:ETD59/31/22



Fuan Electronics

TEL :0086-514-87693589
 EML :sales@fuantronics.net
 WEB:www.fuantronics.net

Make: P.Xiao

Material Number: A49590200100

Checked: Beson. zhan

Document/Rev: 00

Approved: Anson. zhan

Date of Recognition: Oct./22/2019