

MOUNTING CLIP

DRAWING NO:ER-14.5-1

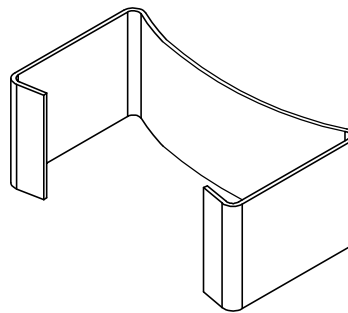
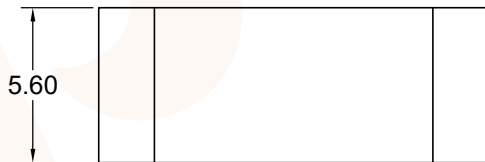
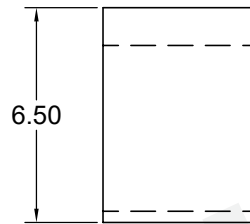
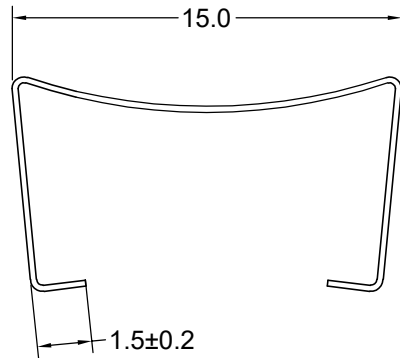

Tolerances unless otherwise specified:
 0<L≤4±0.10 4<L≤16±0.20
 16<L≤45±0.30 45≤L±0.40
 Wall thickness:0.15±0.05 Angle: ±1°

Dimensions:
(mm)



REMARK

Mould No.:

Clip Material: SUS301 0.15T

Code No.: :FAY01046

UL Recognition:



Fuan Electronics

TEL :0086-514-87693589
 EML :sales@fuantronics.net
 WEB:www.fuantronics.net

Make: P.Xiao

Material Number: 221ER1450101

Checked: Beson. zhan

Document/Rev: 00

Approved: Anson. zhan

Date of Recognition: Dec./09/2019