

MOUNTING CLIP

DRAWING NO:ER-11.5-1

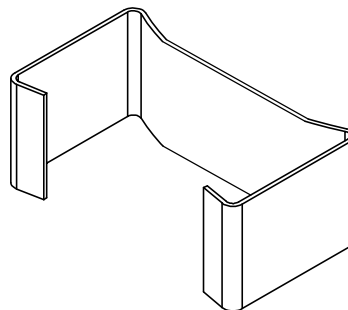
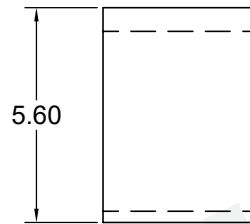
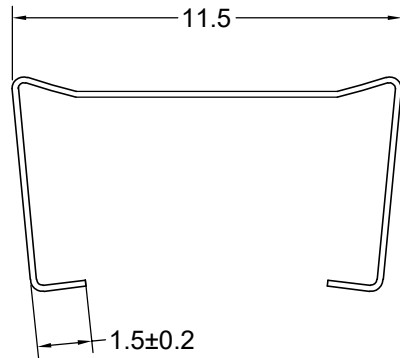

Tolerances unless otherwise specified:  
 0<L≤4±0.10 4<L≤16±0.20  
 16<L≤45±0.30 45≤L±0.40  
 Wall thickness:0.15±0.05 Angle: ±1°

Dimensions:  
(mm)



REMARK

Mould No.:	Clip Material: SUS301 0.15T
Code No.: :FAY01045	UL Recognition:



**Fuan Electronics**  
 TEL :0086-514-87693589  
 EML :sales@fuantronics.net  
 WEB:www.fuantronics.net

Make: P.Xiao	Material Number: 221ER1150100
Checked: Beson. zhan	Document/Rev: 00
Approved: Anson. zhan	Date of Recognition: Dec./09/2019