

MOUNTING CLIP

DRAWING NO:EF-20

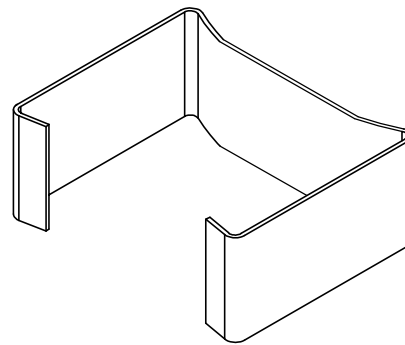
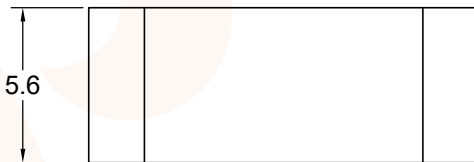
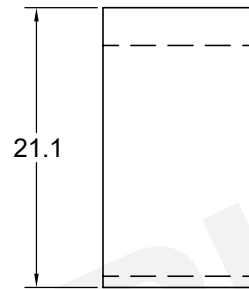
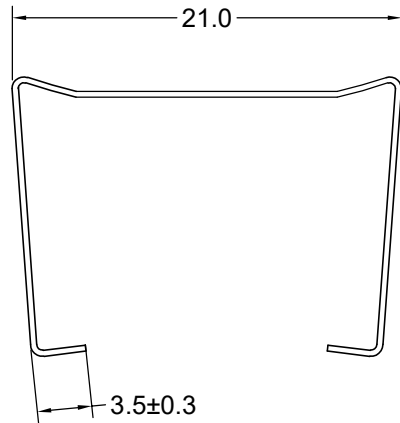

Tolerances unless otherwise specified:  
 0<L≤4±0.10 4<L≤16±0.20  
 16<L≤45±0.30 45≤L±0.40  
 Wall thickness:0.3±0.05 Angle:±1°

Dimensions:  
(mm)



REMARK

Mould No.: Clip Material: SUS301 0.3T

Code No.: :FAY01045 UL Recognition:



**Fuan Electronics**  
 TEL :0086-514-87693589  
 EML :sales@fuantronics.net  
 WEB:www.fuantronics.net

Make: P.Xiao	Material Number: 221EF2000000
Checked: Beson.zhan	Document/Rev: 00
Approved: Anson.zhan	Date of Recognition: Dec./09/2019