

COIL FORMER

General data 20-pins EE85/44/26 coil former

| PARAMETER | SPECIFICATION |
|-------------------------------|--|
| Coil former material | polyamid (PA66), glass reinforced, flame retardant in accordance with "UL 94HB"; UL file number E41938 |
| Pin material | copper-tin alloy (CuSn), tin (Sn) plated |
| Maximum operating temperature | 130°C, "IEC 60085", class B |
| Resistance to soldering heat | "IEC 60068-2-20", Part 2, Test Tb, method 1B, 350 °C, 3.5 s |
| Soldeerability | "IEC 60068-2-20", Part 2, Test Ta, method 1 |

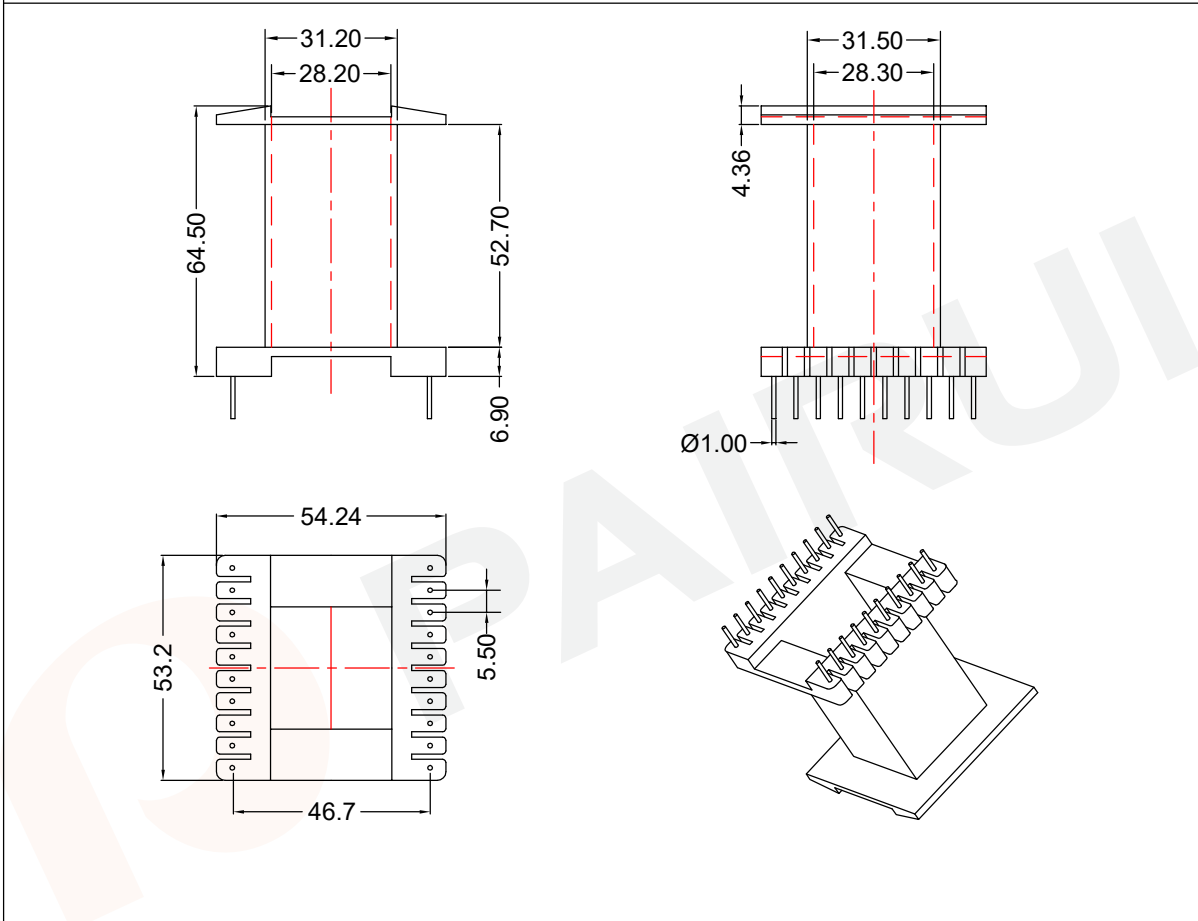

Winding data and area product for 20-pins EE85/44/26 coil former

| NUMBER OF SECTIONS | WINDING AREA (mm ²) | MINIMUM WINDING WIDTH (mm) | AVERAGE LENGTH OF TURN (mm) | AREA PRODUCT Ae x Aw (mm ⁴) | TYPE NUMBER |
|--------------------|---------------------------------|----------------------------|-----------------------------|---|----------------|
| 1 | 572 | 52.70 | 169 | 392390 | EE-8501-1S-20P |

Tolerances unless otherwise specified:
 0<L≤4±0.10 4<L≤16±0.20
 16<L≤45±0.30 45≤L±0.40
 Pin Dim:±0.05 Thickness:±0.20 Pin Pitch:±0.20

Dimensions:
(mm)



REMARK

Mould No.: EE8501

Bobbin material: PA66

Code No.: FAY01091

Available for Fuan core: EE85/44/26



Fuan Electronics

TEL :0086-514-87693589
 EML :sales@fuantronics.net
 WEB:www.fuantronics.net

Make: P.Xiao

Material Number: A40850100100

Checked: Beson. zhan

Document/Rev: 00

Approved: Anson. zhan

Date of Recognition: Oct./17/2019