

General data 4-pins T16 series case

PARAMETER	SPECIFICATION
Case material	polybutyleneterephthalate (PBT), glass reinforced, flame retardant in accordance with "UL 94V-0"; UL file number E59481
Pin material	copper-tin alloy (CuSn), tin (Sn) plated
Maximum operating temperature	130°C, "IEC 60085", class B
Resistance to soldering heat	"IEC 60068-2-20", Part 2, Test Tb, method 1B, 350 °C, 3.5 s
Soldeerability	"IEC 60068-2-20", Part 2, Test Ta, method 1

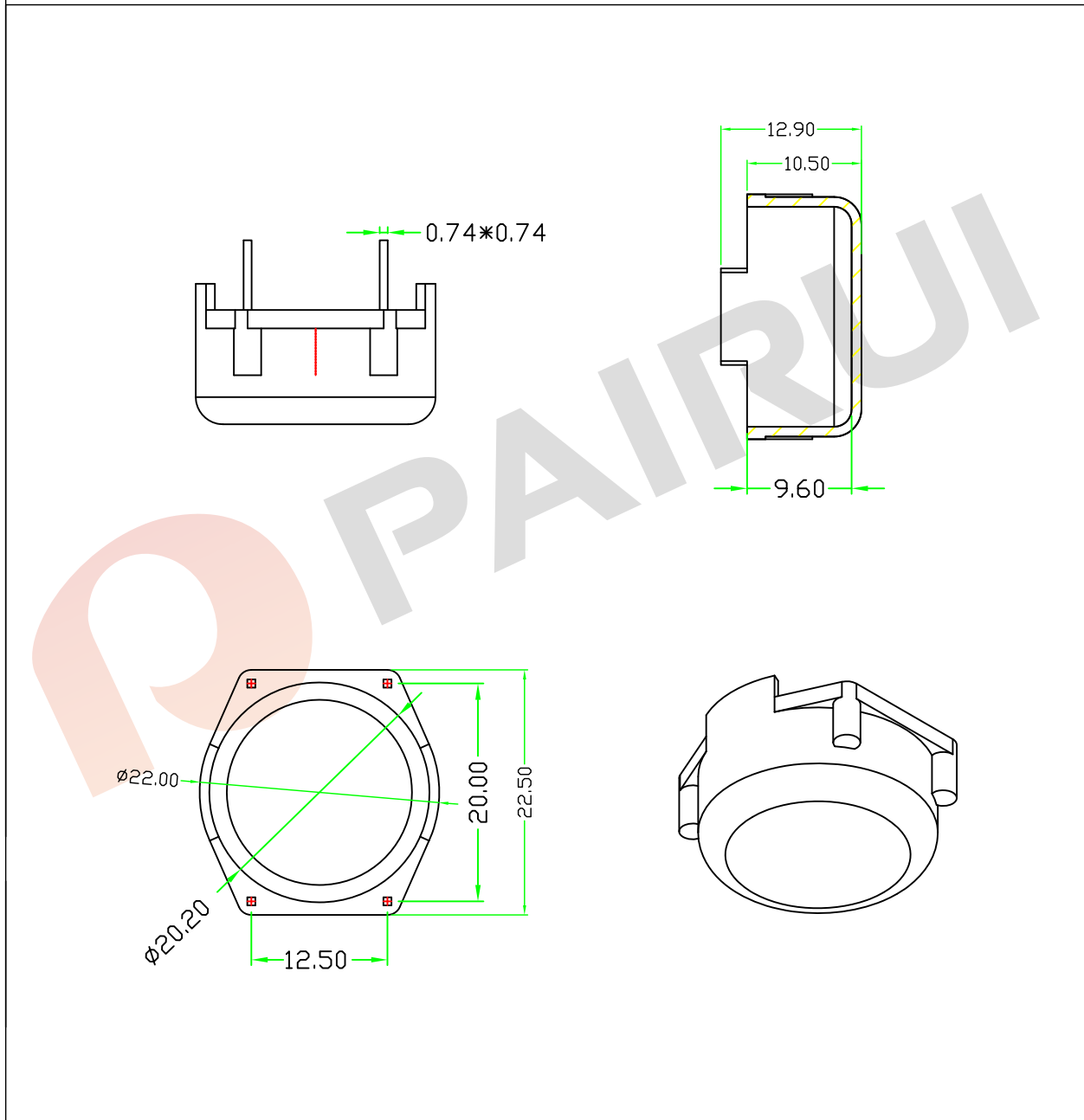

Tolerances unless otherwise specified: 0<L≤4±0.10 4<L≤16±0.20 16<L≤45±0.30 45≤L±0.40 Pin Dim:±0.05 Thickness:±0.20 Pin Pitch:±0.20	Dimensions: (mm)	TYPE NUMBER: CASE-17-001-4P		
		Mould No.: EB17-001	Bobbin material: PBT	
		Code No.: FAY01091	Available for Fuan core: T16 Series	
Fuan Electronics TEL :0086-514-87693589 EML :sales@fuantronics.net WEB:www.fuantronics.net	Make: P.Xiao	Material Number: A4S170100200		
	Checked: Beson. zhan	Document/Rev: 00		
	Approved: Anson. zhan	Date of Recognition: Oct./21/2019		