

General data 8-pins T16 series case

PARAMETER	SPECIFICATION
Case material	polybutyleneterephthalate (PBT), glass reinforced, flame retardant in accordance with "UL 94V-0"; UL file number E59481
Pin material	copper-tin alloy (CuSn), tin (Sn) plated
Maximum operating temperature	130 °C, "IEC 60085", class B
Resistance to soldering heat	"IEC 60068-2-20", Part 2, Test Tb, method 1B, 350 °C, 3.5 s
Soldeerability	"IEC 60068-2-20", Part 2, Test Ta, method 1

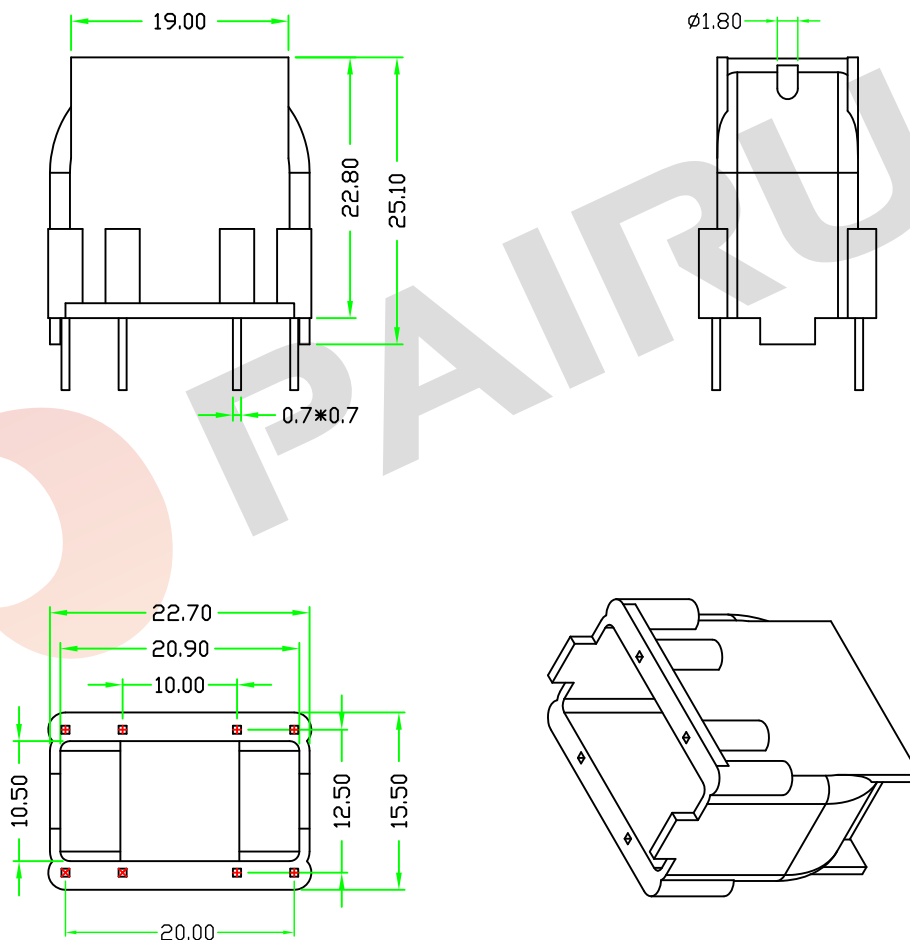

Tolerances unless otherwise specified:
 $0 < L \leq 4 \pm 0.10$ $4 < L \leq 16 \pm 0.20$
 $16 < L \leq 45 \pm 0.30$ $45 \leq L \pm 0.40$
 Pin Dim: ± 0.05 Thickness: ± 0.20 Pin Pitch: ± 0.20

Dimensions:
(mm)



TYPE NUMBER: CASE-16-002-8P

Mould No.: EB16-002

Bobbin material: PBT

Code No.: FAY01091

Available for Fuan core: T16 Series



Fuan Electronics

TEL :0086-514-87693589
 EML :sales@fuantronics.net
 WEB:www.fuantronics.net

Make: P.Xiao

Material Number: A4S160200100

Checked: Beson. zhan

Document/Rev: 00

Approved: Anson. zhan

Date of Recognition: Oct./21/2019